

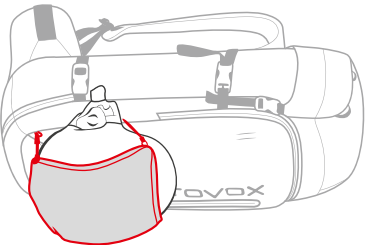

SIZE/ GRÖSSE/ TAILLE/ DIMENSIONE	45 L	42 L (S)	35 L	32 L (S)
<b>WEIGHT/ GEWICHT/ POIDS/ PESO</b>	1 490 g	1 470 g	1 440 g	1 410 g
<b>MIN. WEIGHT/ GEWICHT/ POIDS MIN./ PESO MIN.</b>	1 420 g	1 400 g	1 370 g	1 340 g
<b>BACKLENGTH</b> RÜCKENLÄNGE/ DOS/ LUNG. DEL DORSO	Regular	Short (S)	Regular	Short (S)

**HELMET FIXATION /  
HELMNETZ/ FILET CASQUE /  
RETE DI FISSAGGIO CASCO**



**PEAK BACKPACK  
VIDEO GUIDE:**



SCAN QR-CODE TO PLAY:



[www.ortovox.com/backpack-tutorial](http://www.ortovox.com/backpack-tutorial)

**DE** Zusätzliche Teile findest du im Deckelfach.

**EN** Additional parts are stored in the lid compartment.

**FR** D'autres parties sont conservés dans le compartiment du couvercle. **IT** Componenti aggiuntive sono stivate all'interno del comparto del coperchio.

HIGH ALPINE SERIES  
PEAK 45 / 42 S / 35 / 32 S



**SEPARATE SAFETY COMPARTMENT /**  
SEPARATES SICHERHEITSFACH /  
COMPARTIMENT SÉPARÉ POUR L'ÉQUIPEMENT  
CE SÉCURITÉ / COMPARTO DI SICUREZZA  
SEPARATO

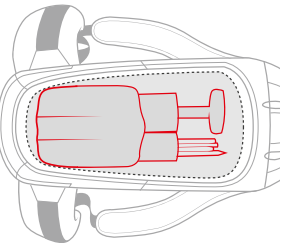

**CIRCUMFERENTIAL ZIPPER /**  
UMLAUFENDER REISSVERSCHLUSS /  
ZIP CIRCULAIRE / ZIP CIRCOLARE

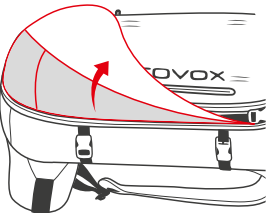

**HYDRATION SYSTEM COMPATIBLE /**  
TRINKSYSTEMVORBEREITUNG /  
COMPATIBLE SYSTÈME D'HYDRATION /  
PREDISPOSIZIONE PER SISTEMA  
D'IDRATAZIONE

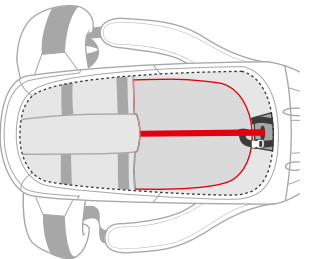

**SWISSWOOL FULL CONTACT BACK SYSTEM /**  
SWISSWOOL FULL CONTACT RÜCKENSYSTEM /  
SYSTEME DORSAL SWISSWOOL FULL  
CONTACT / SISTEMA DORSALE SWISSWOOL  
FULL CONTACT

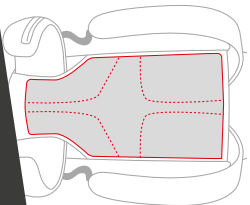

HIGH ALPINE SERIES  
PEAK 45 / 42S / 35 / 32S



**CRAMPON FASTENING /**  
STEIGEISENFIXIERUNG / FIXATION  
CRAMPONS / FISSAGGIO RAMPONI

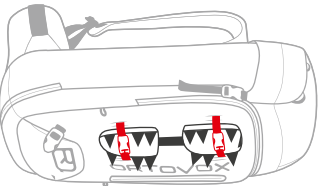

.....  
**ICE AXE FASTENING /** PICKELBEFESTIGUNG /  
FIXATION PIOLETS / FISSAGGIO PICCOZZA

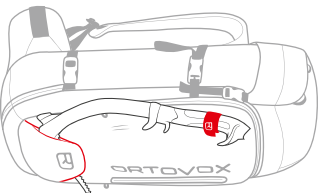

**ROPE ATTACHMENT /** SEILFIXIERUNG /  
FIXATION DE LA CORDE / FISSAGGIO CORDA

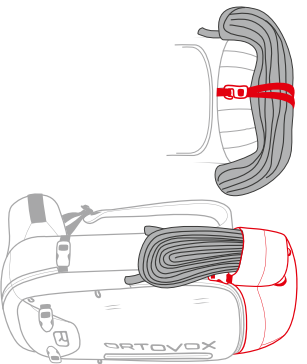

.....  
**RAPID CLOSURE /** SCHNELLEVERSCHLUSS /  
FERMETURE RAPIDE / CHIUSURA RAPIDA

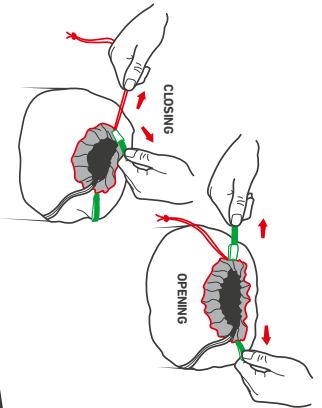

HIGH ALPINE SERIES  
PEAK 45 / 42S / 35 / 32S



**SNOWBOARD &  
SNOWSHOE ATTACHMENT/**  
SNOWBOARD- & SCHNEESCHUHALTERUNG/  
FIXATION DU SNOWBOARD ET DES  
RAQUETTES/ FISSAGGIO SNOWBOARD E  
RACCHETTE DA NEVE

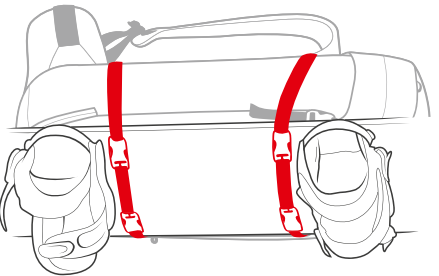

**A-SKIFIX**

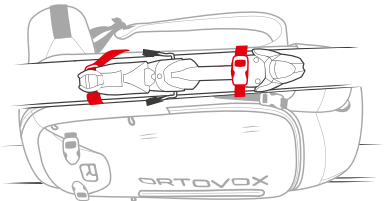

**D-SKIFIX**

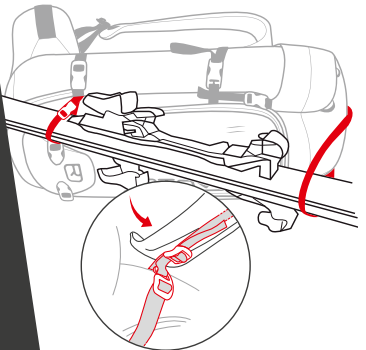

HIGH ALPINE SERIES  
PEAK 45 / 42S / 35 / 32S